



工业动力/工业信号控制连接一站式选购



# 工业连接器

选型手册

**Industry Connectors**

**BROCHURE**

Without quality, there is no business tomorrow

没有品质，便没有企业的明天。

**2024**



**Field-wireable connectors**



Shielded



Shielded



**Flange Connectors**



**Y connector**

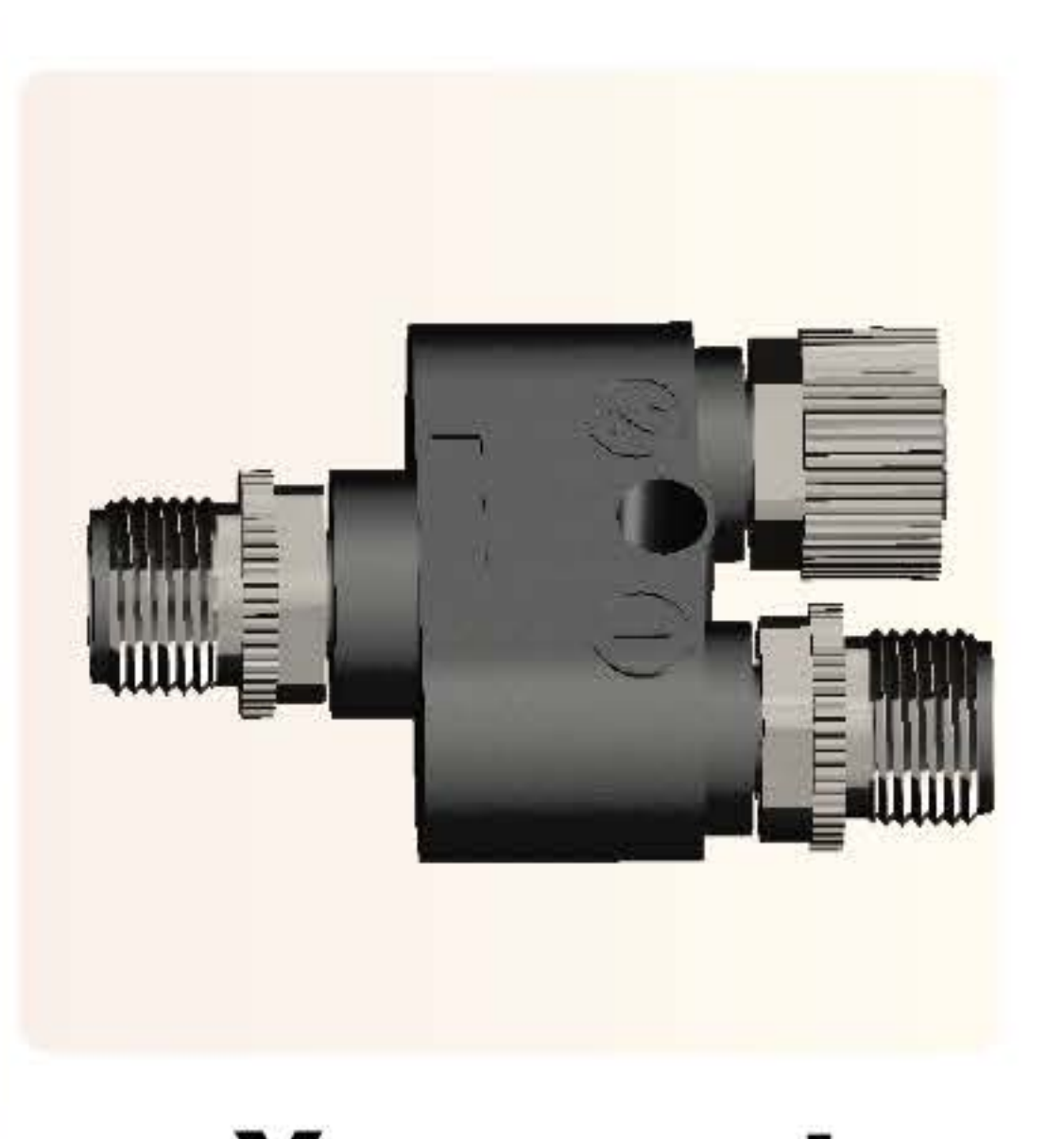

**Y connector**



**RJ45 SERIES**



**RJ45 SERIES**



**RJ45 SERIES**



**Sensor Actuator Cables**

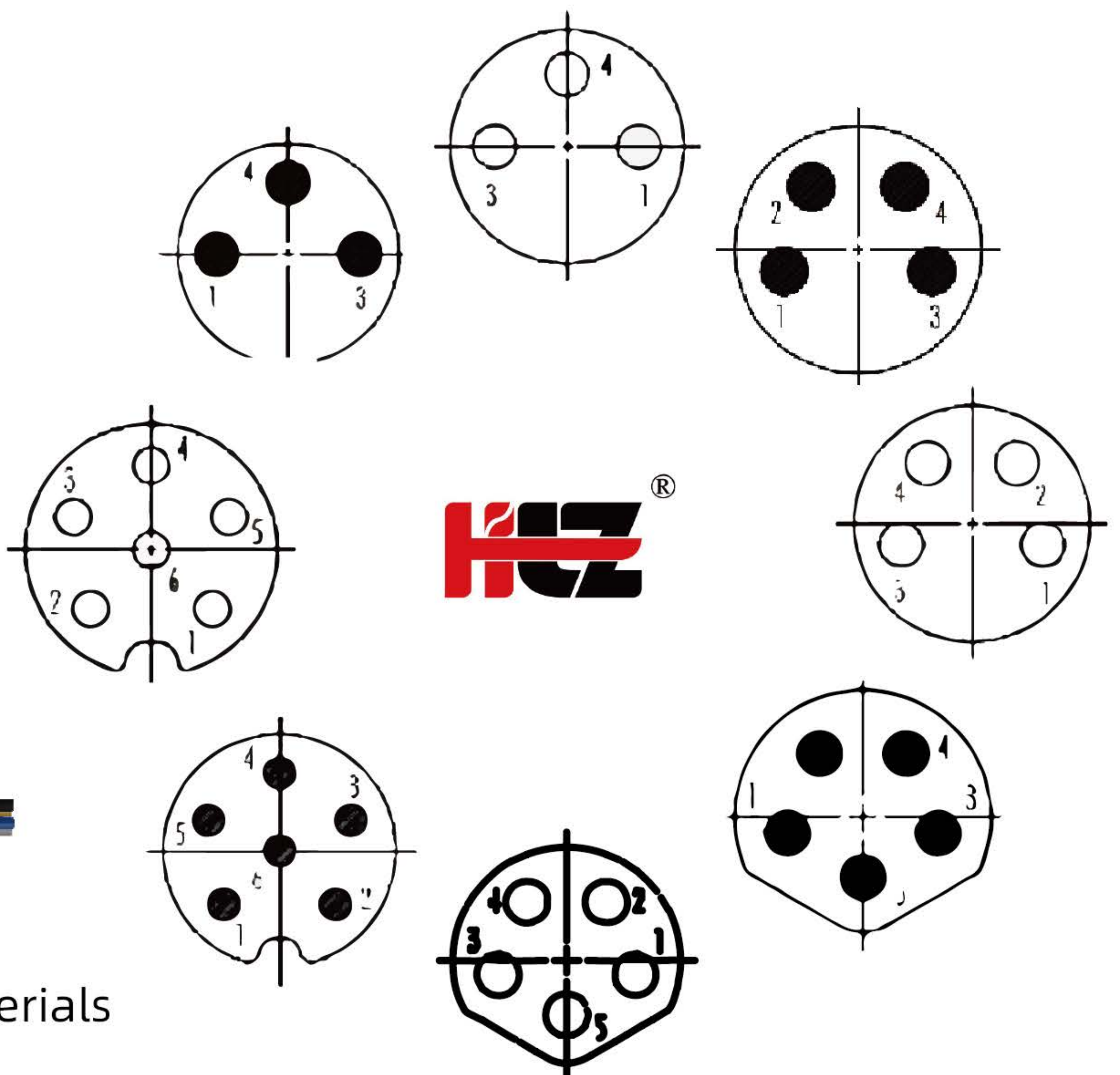

Cable Materials  
PVC / PUR / PTFE & Other Special Materials



# M12

**Field-wireable connectors**

A-code B-code  
C-code D-code  
X-code S-code  
L-code



angled female PG7



angled female PG9



straight female PG7



straight female PG9



straight male PG7



straight male PG9



angled male PG7



angled male PG9



Shielded straight female PG7



Shielded straight female PG9



Shielded angled female PG7



Shielded angled female PG9



Shielded straight male PG7



Shielded straight male PG9



Shielded angled male PG7



Shielded angled male PG9



## Sensor Actuator Cables



Cable Materials  
PVC / PUR / PTFE & Other Special Materials

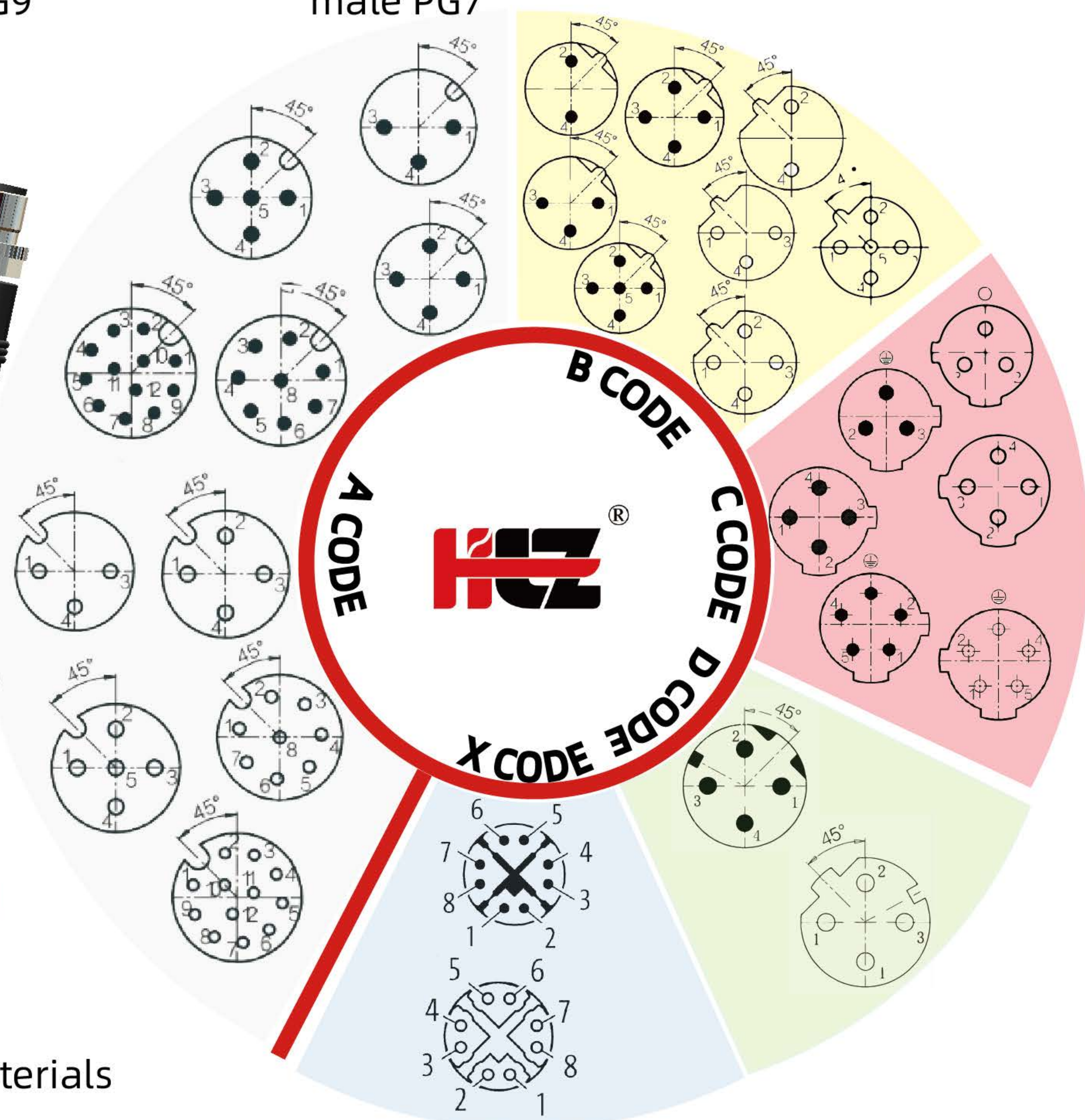



# M16

Field-wireable connectors

Shielded



Cable Materials  
PVC / PUR / PTFE & Other Special Materials



Female Connector with Tail Pipe



Male Connector with Tail Pipe



Shielded



straight male PG7/PG9



straight female PG7/PG9



angled female PG7/PG9



angled male PG7/PG9

## Flange Connectors



rear male



rear female



rear male



front female

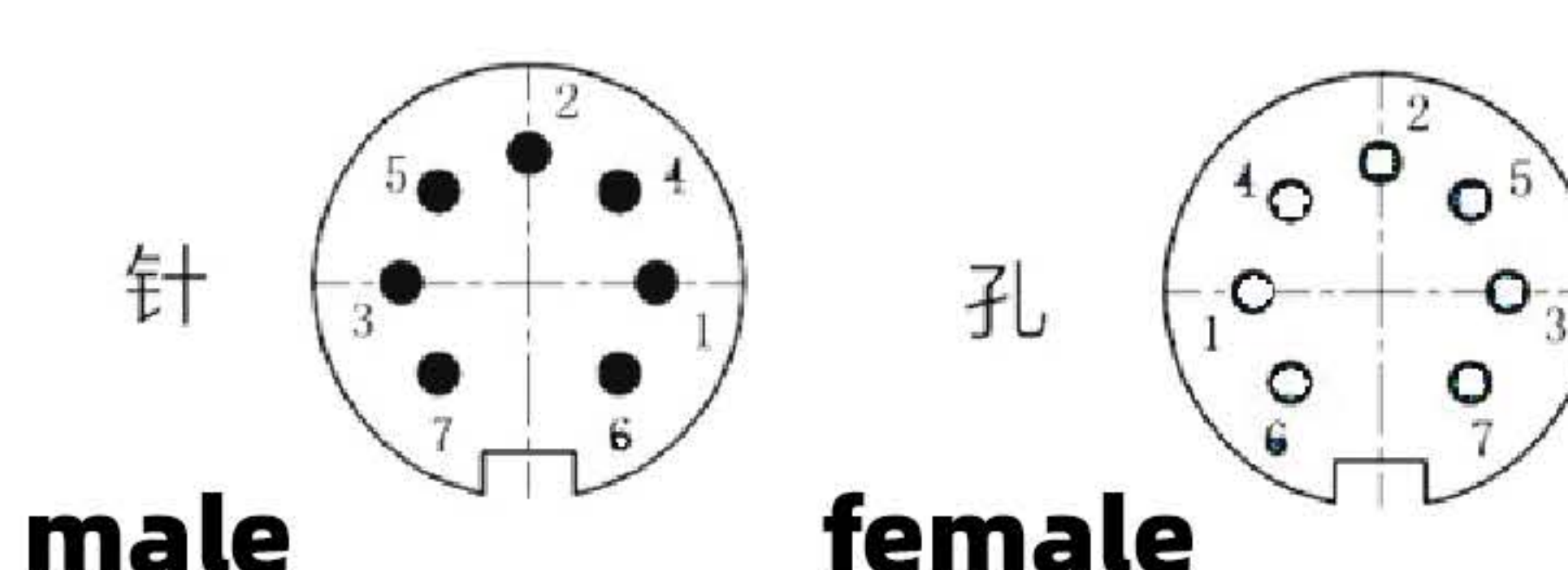
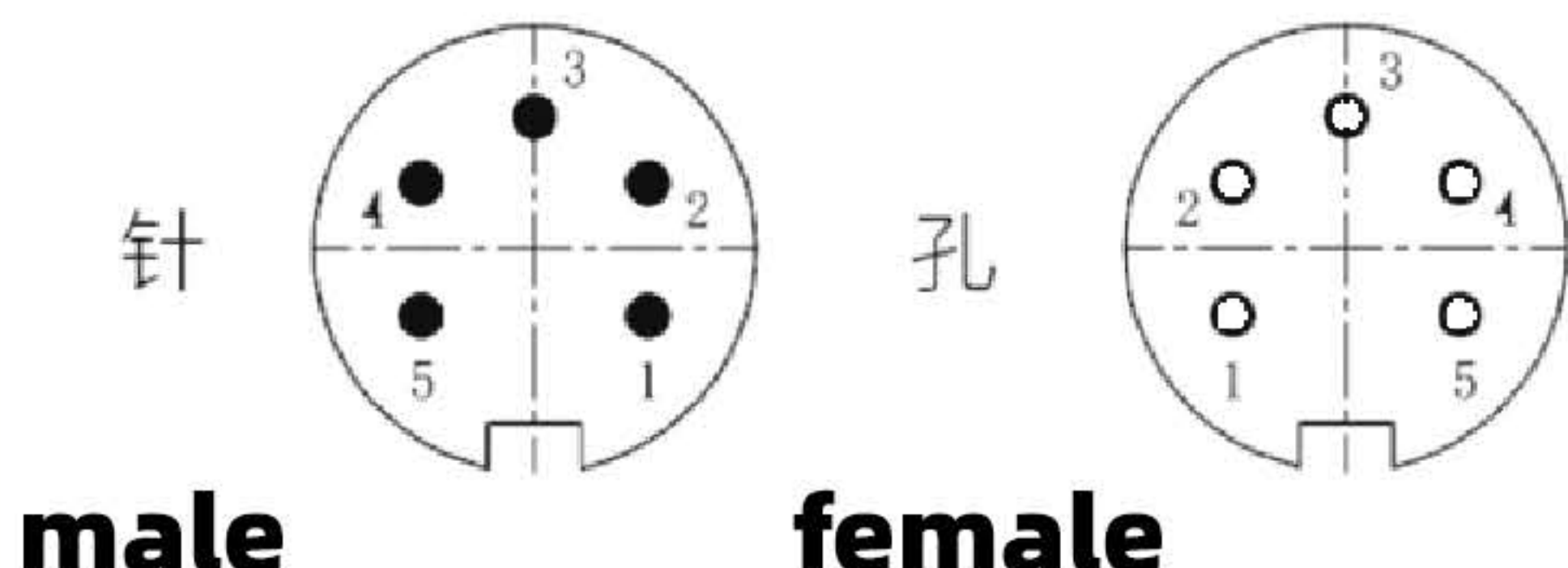
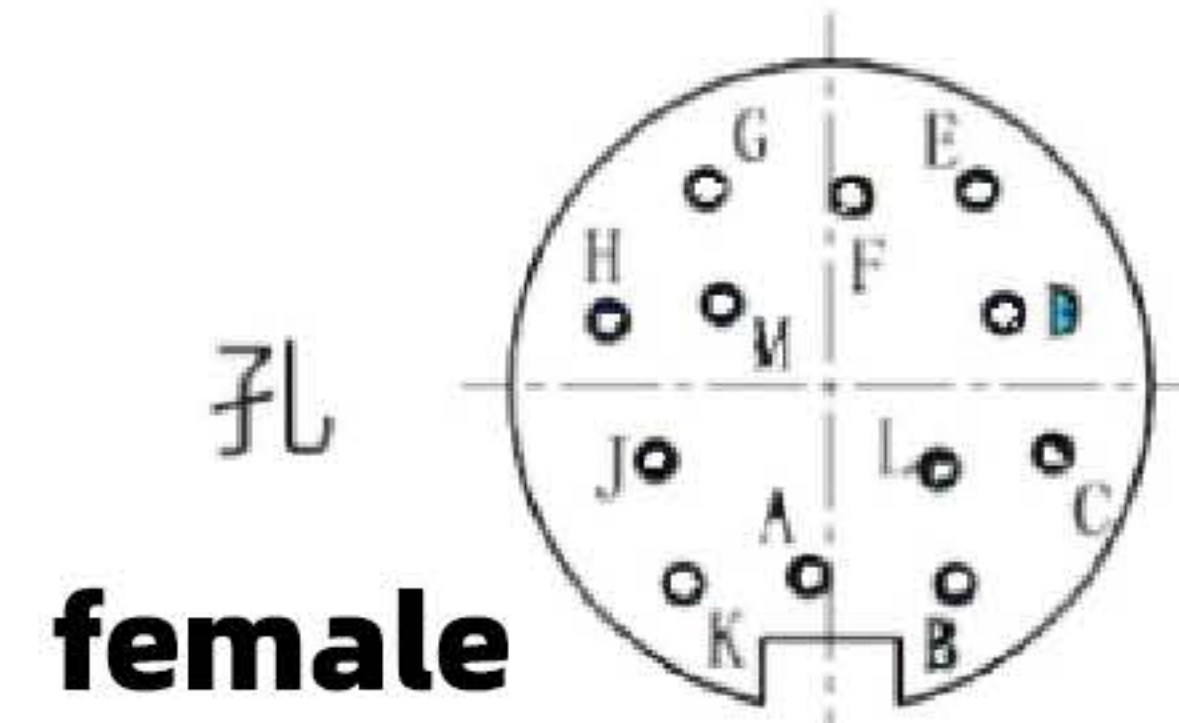
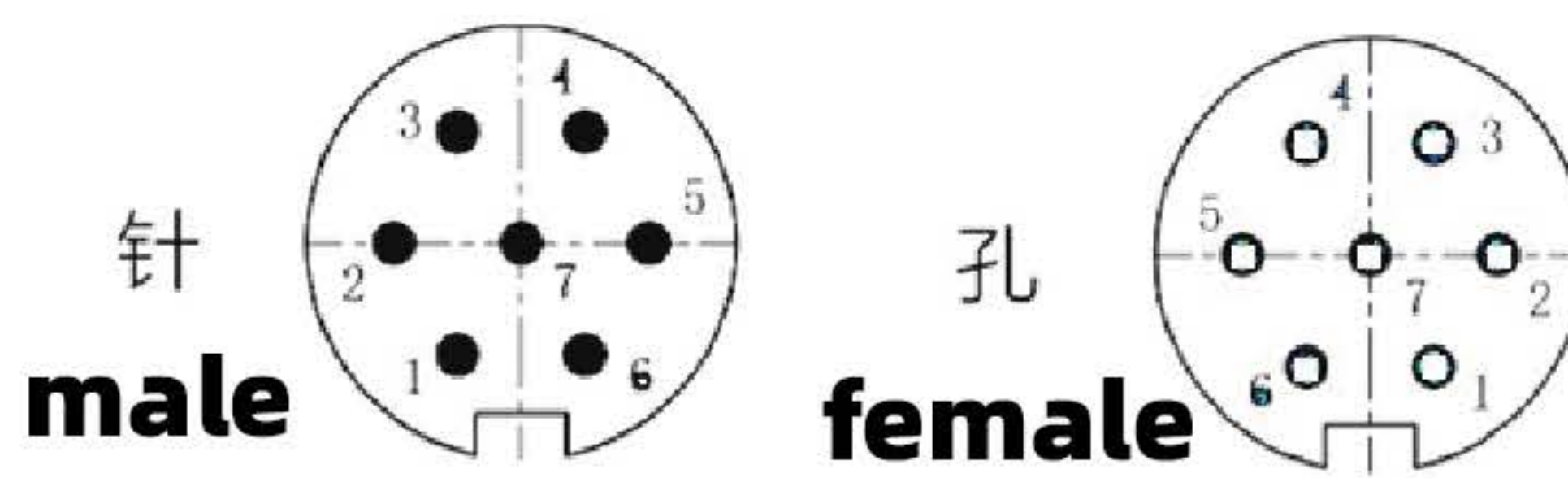
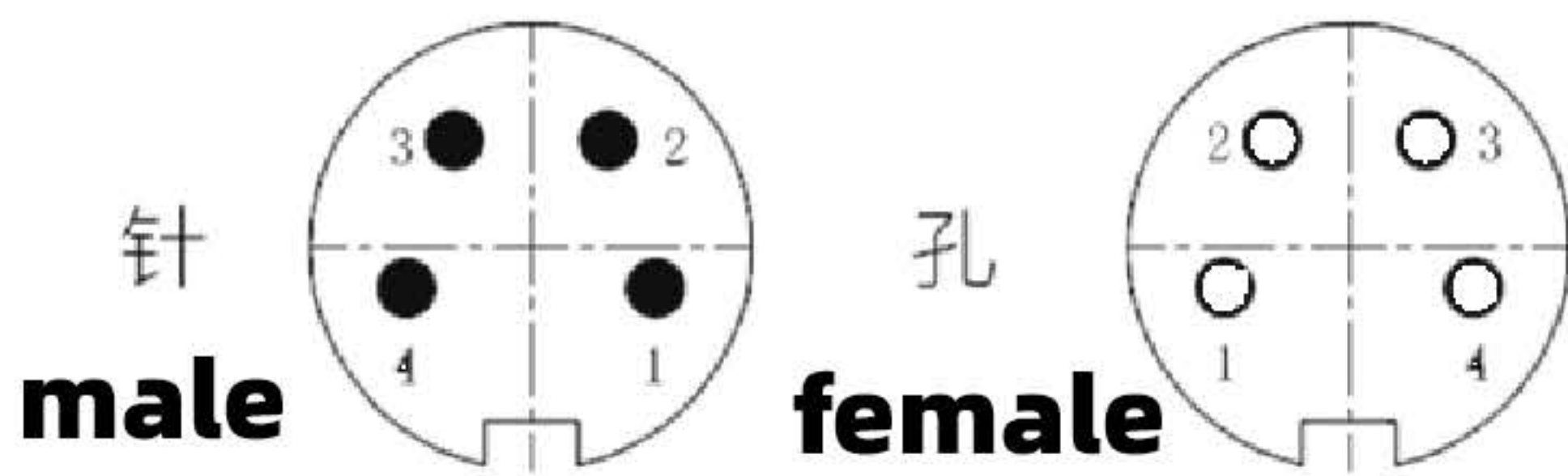
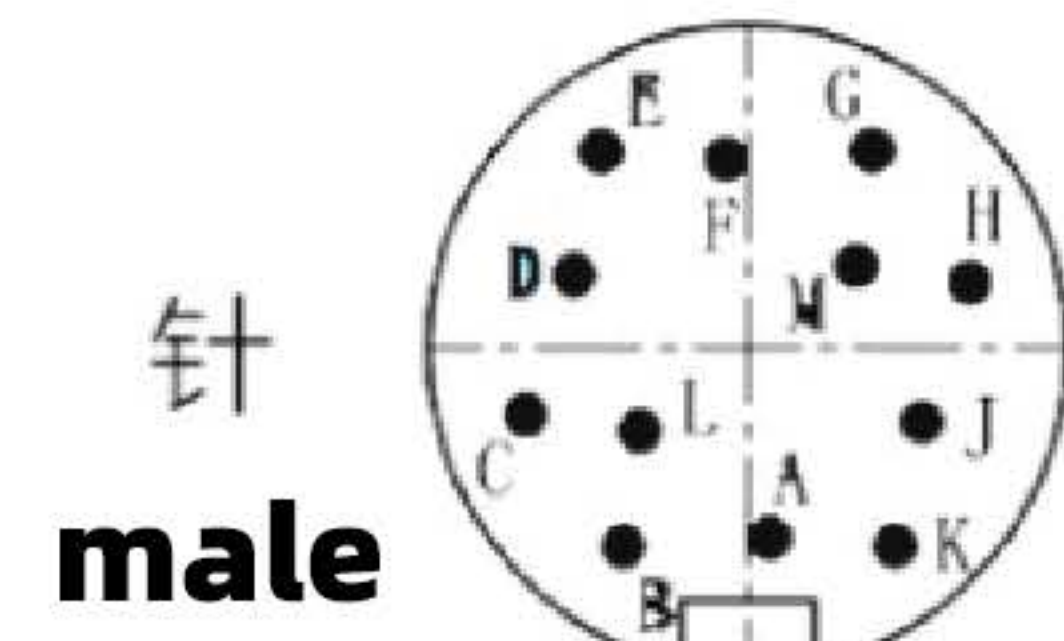
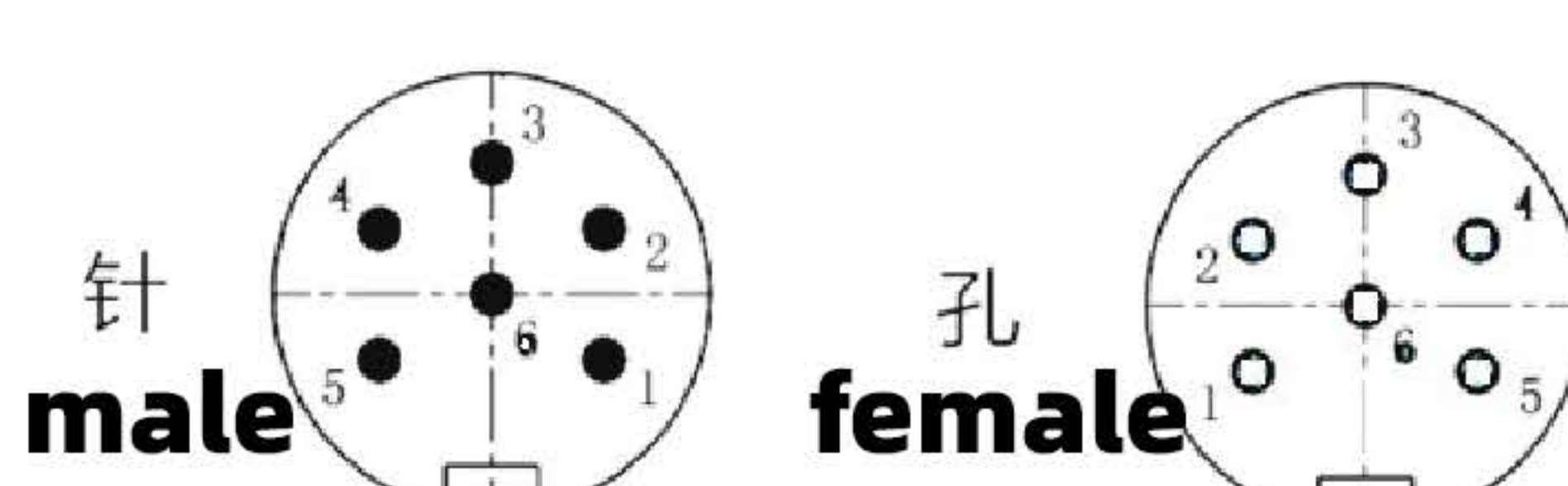
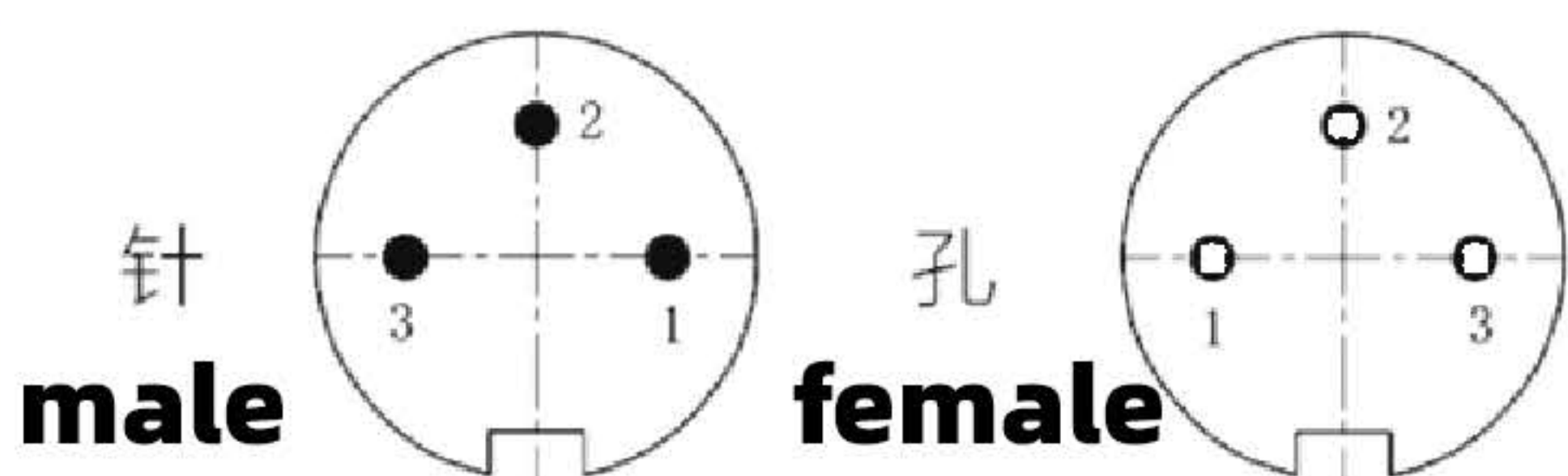

3PIN, 4PIN, 5PIN, 6PIN  
7PIN, 8PIN, 12PIN, 14PIN  
19PIN, 24PIN

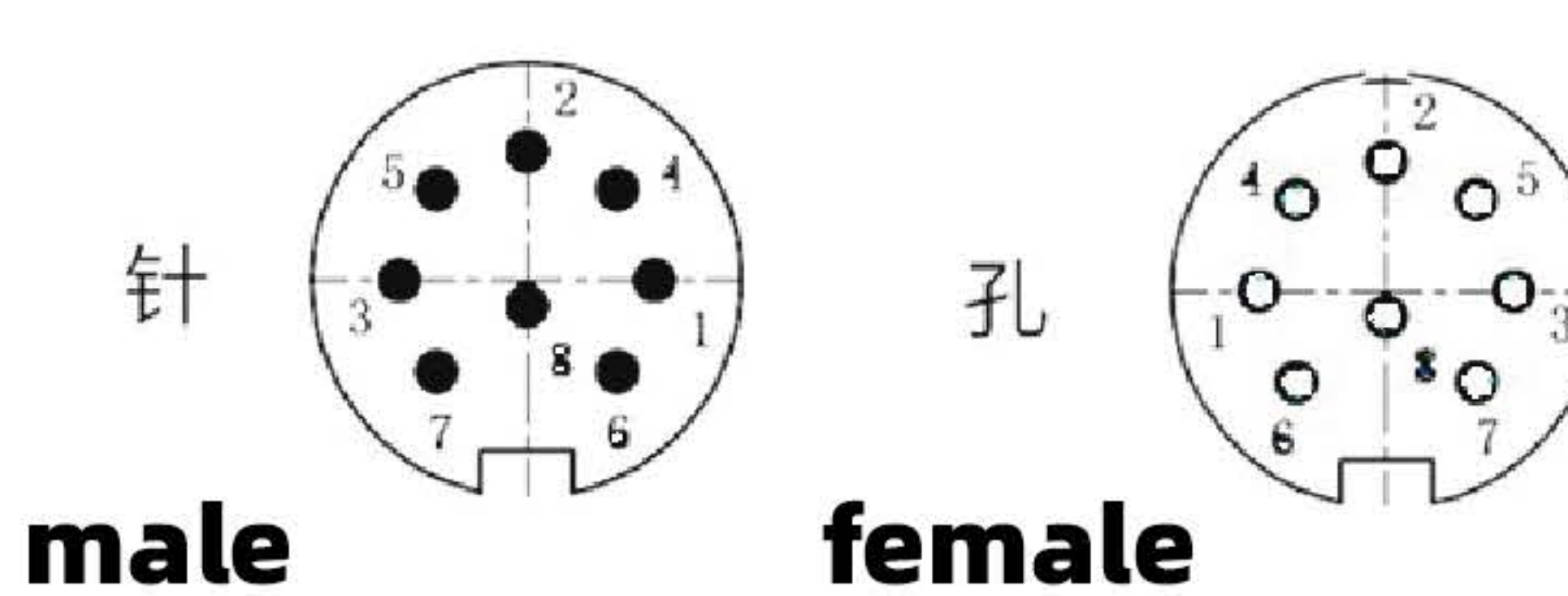
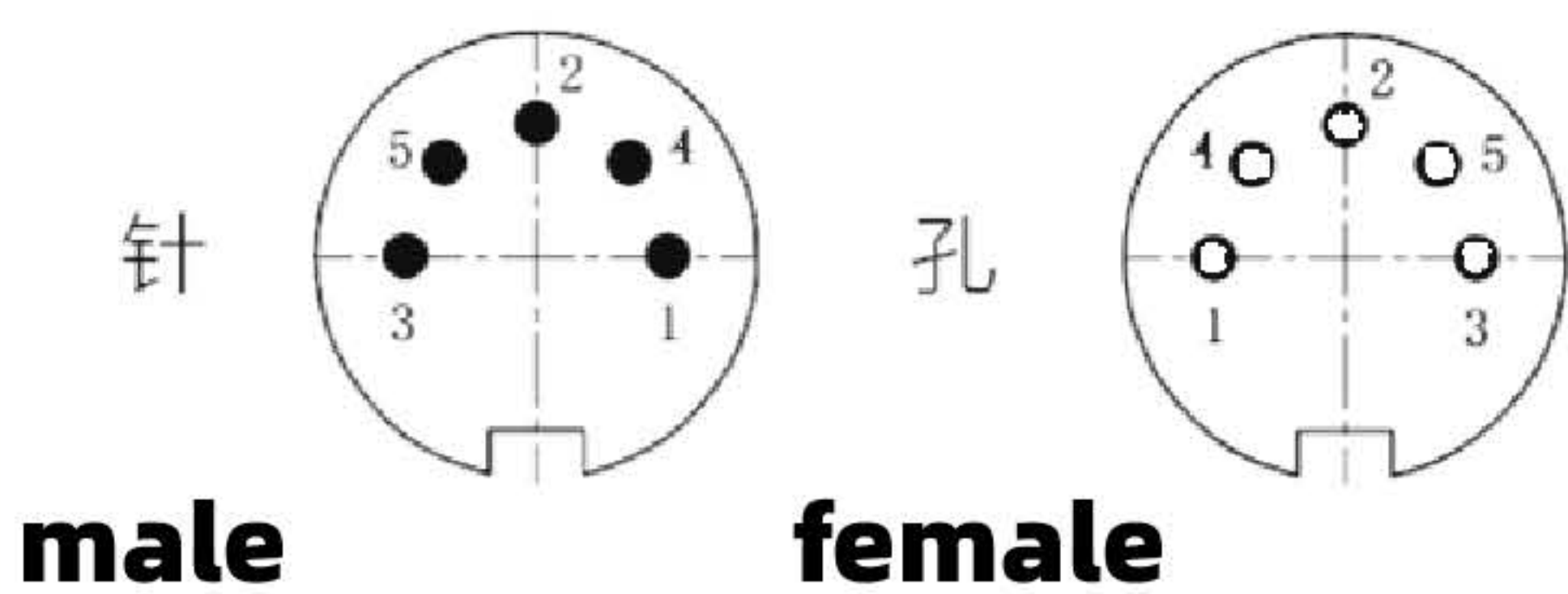



M8/ M12  
Distribution Systems

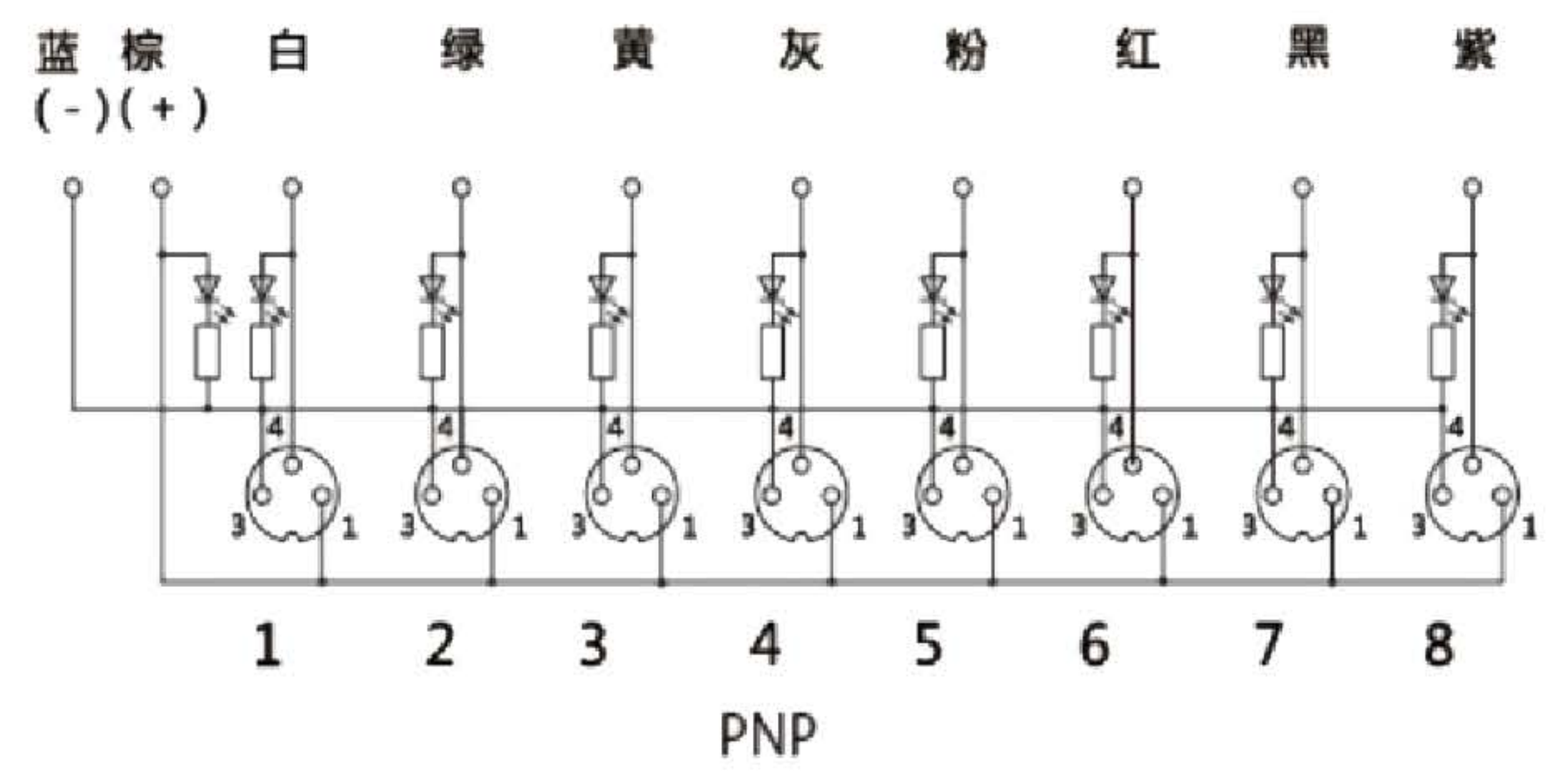

针脚定义:

- Pin 1: (+)
- Pin 3: (-)
- Pin 4: (N/O)/(S1)

LED显示: 电源(绿)  
信号S1(黄)

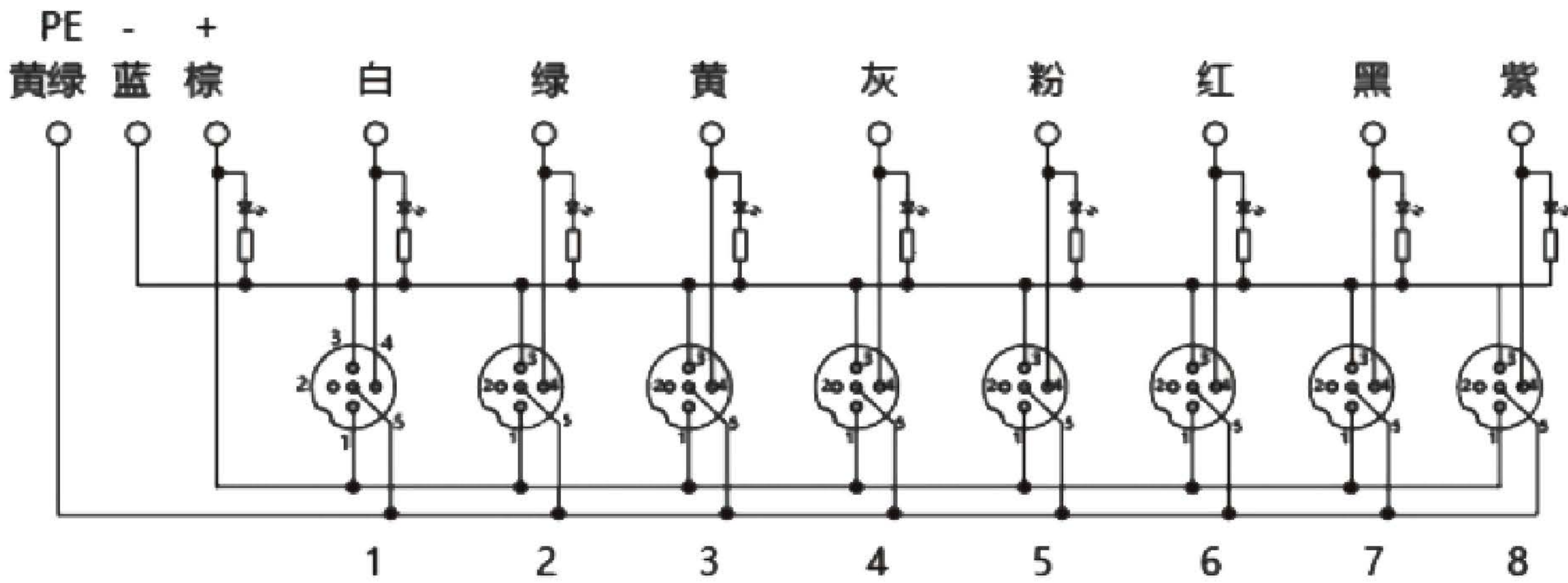
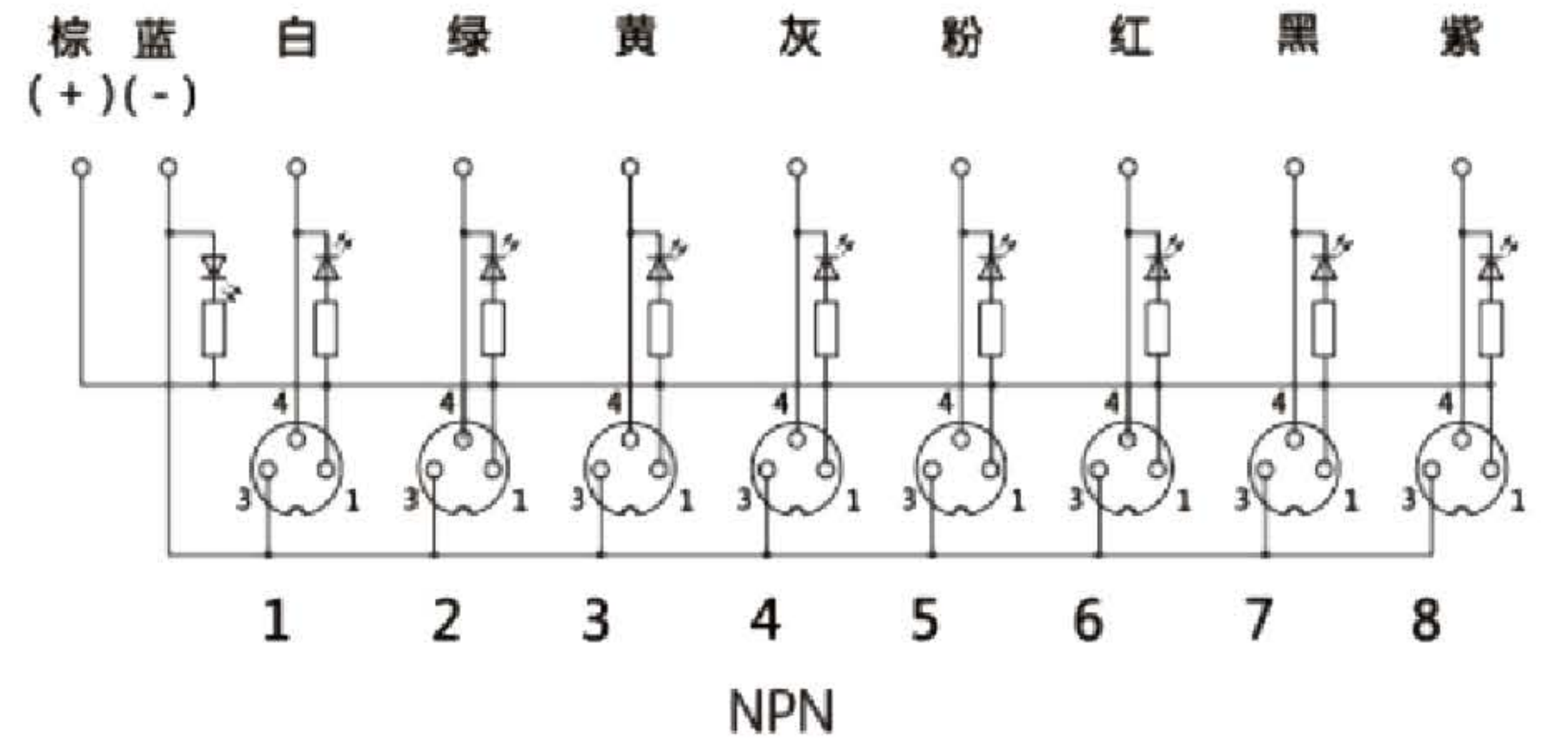
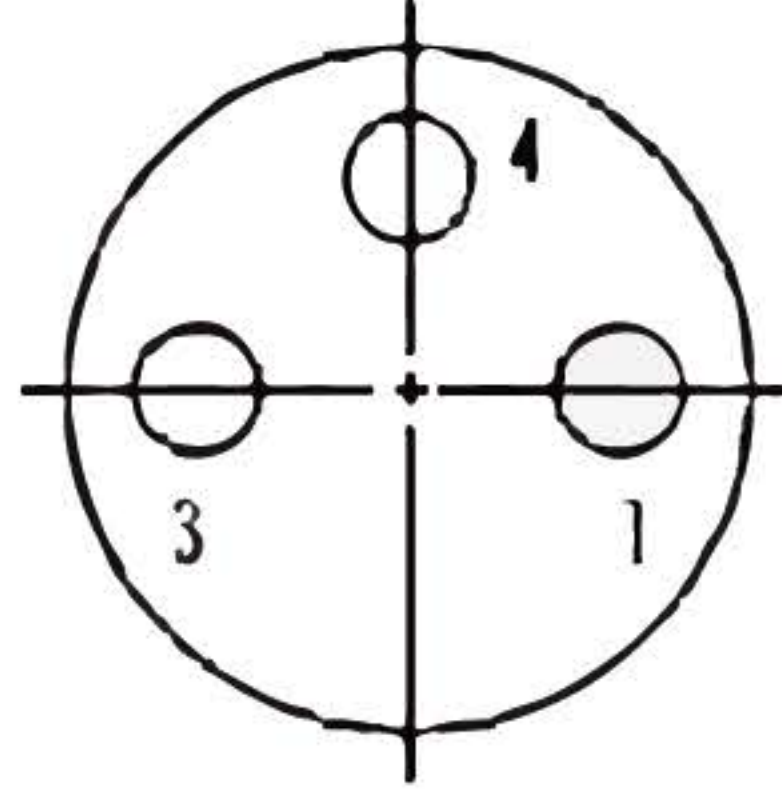

M8/ M12  
Distribution Systems

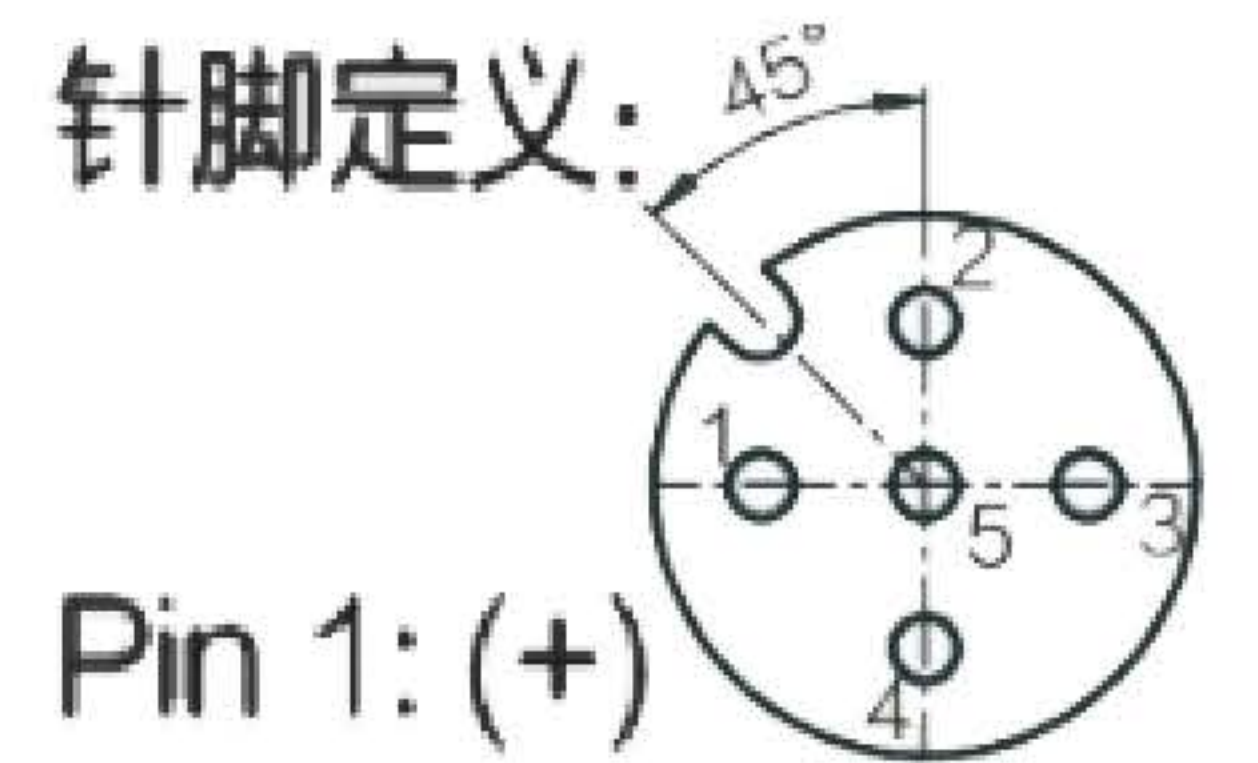

- Pin 1: (+)
- Pin 3: (-)
- Pin 4: (N/O)/(S1)
- Pin 5: (PE)

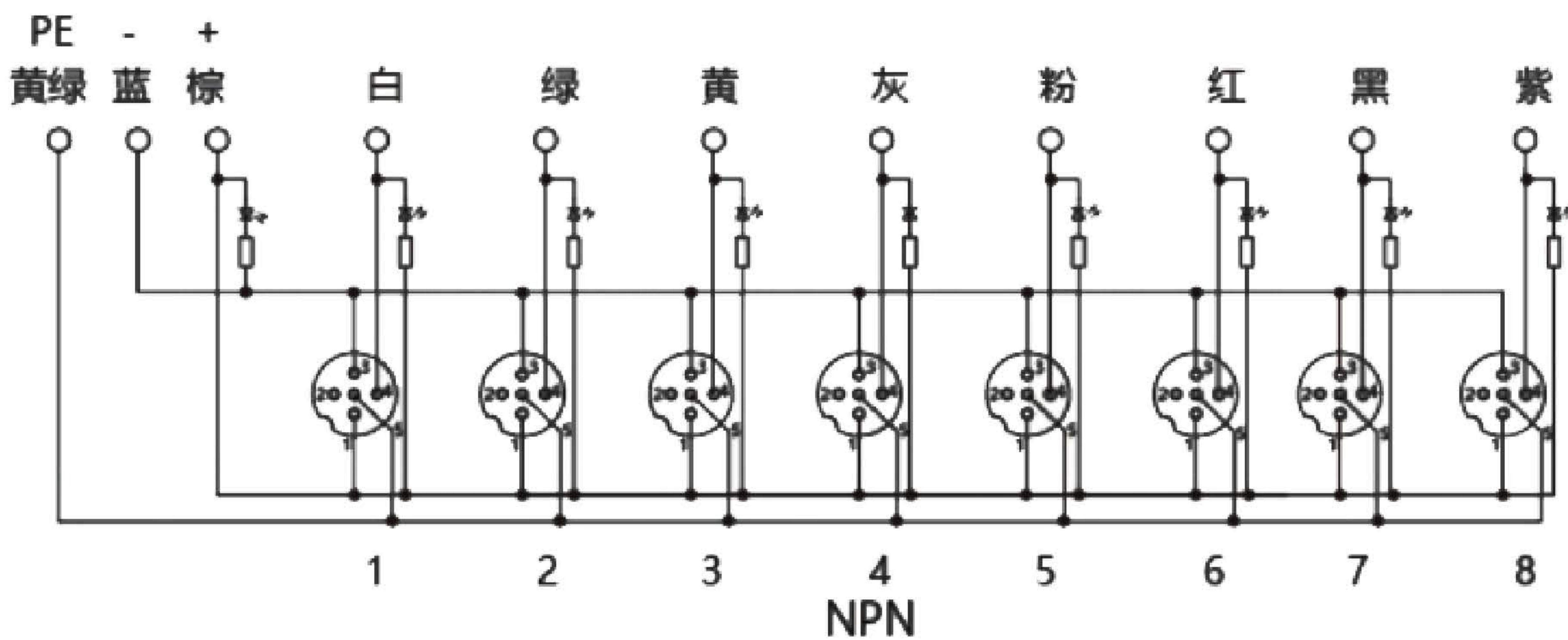

LED显示: 电源(绿)  
信号S1(黄)



# M23

Field-wireable connectors

Shielded

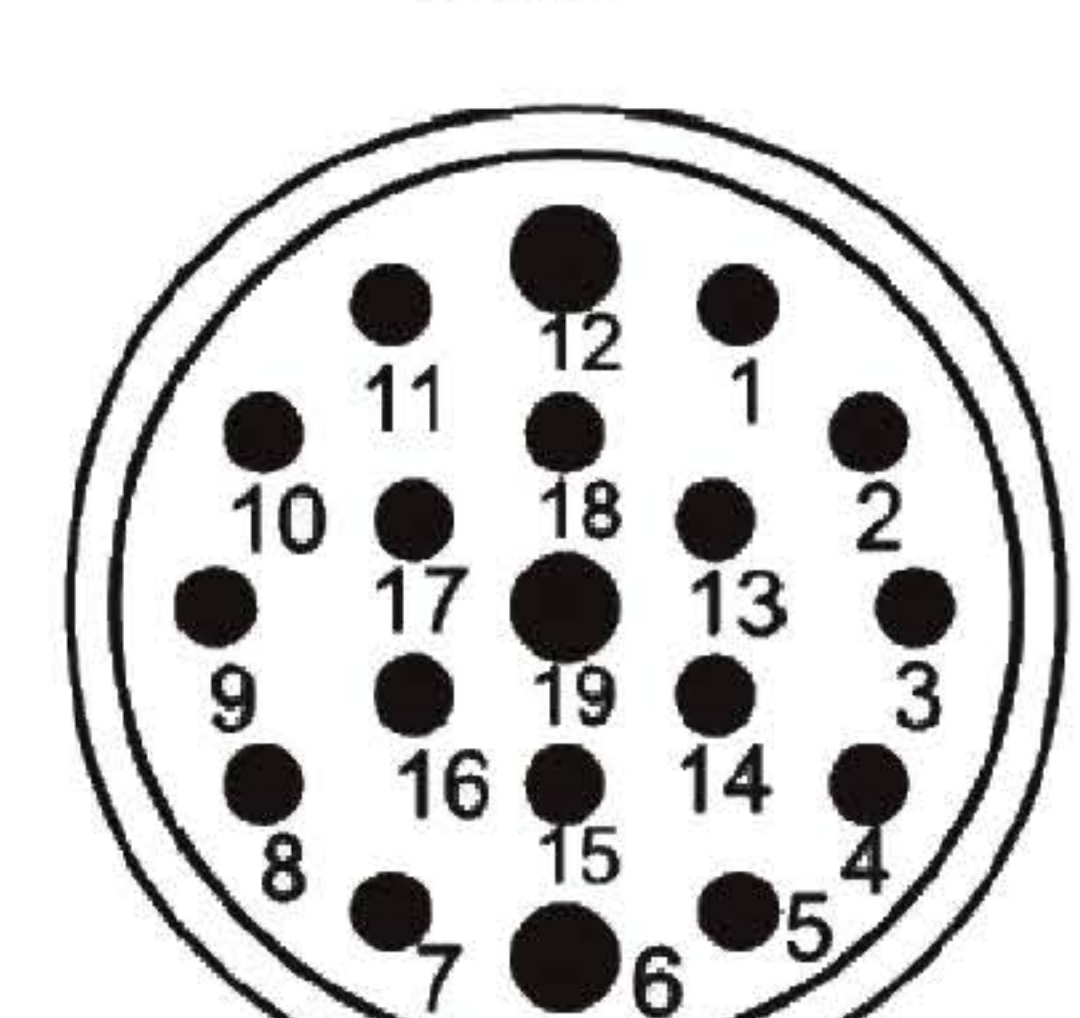
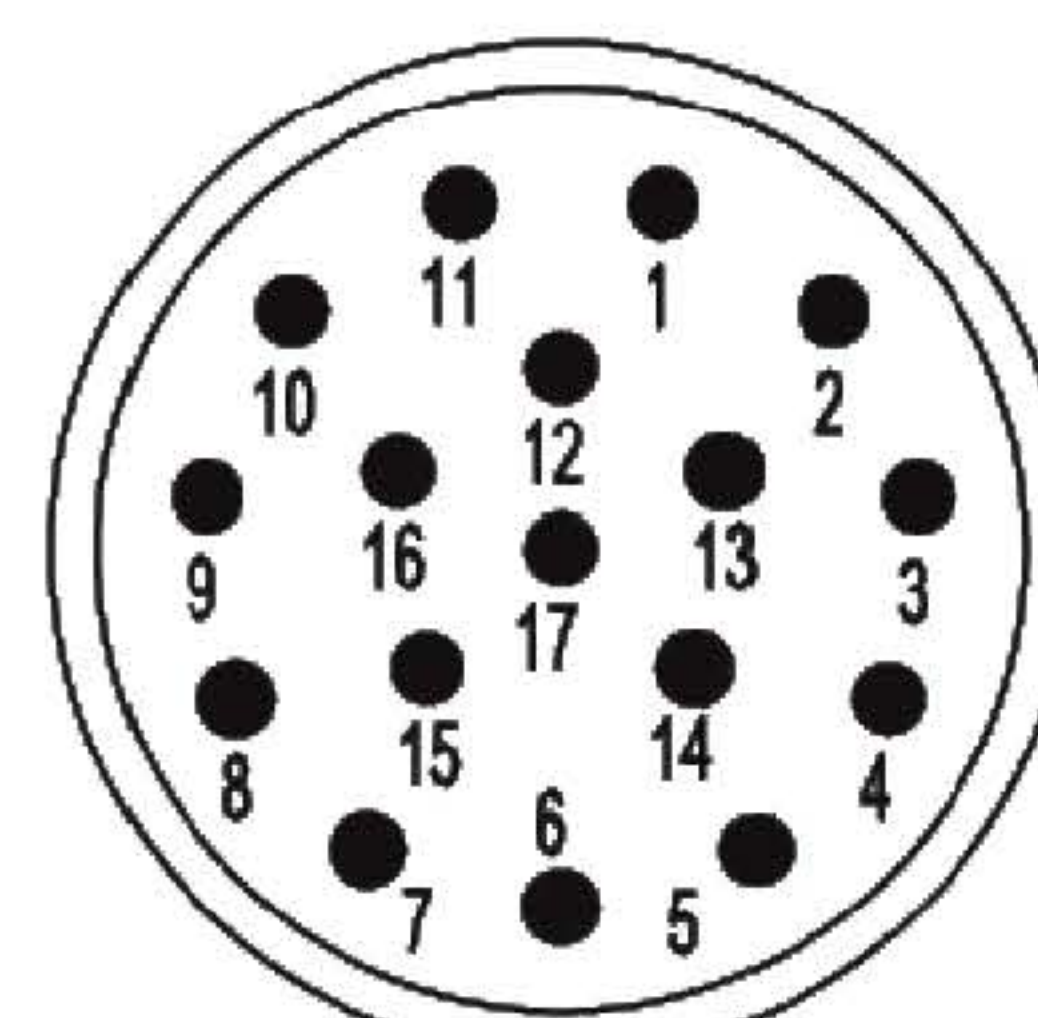
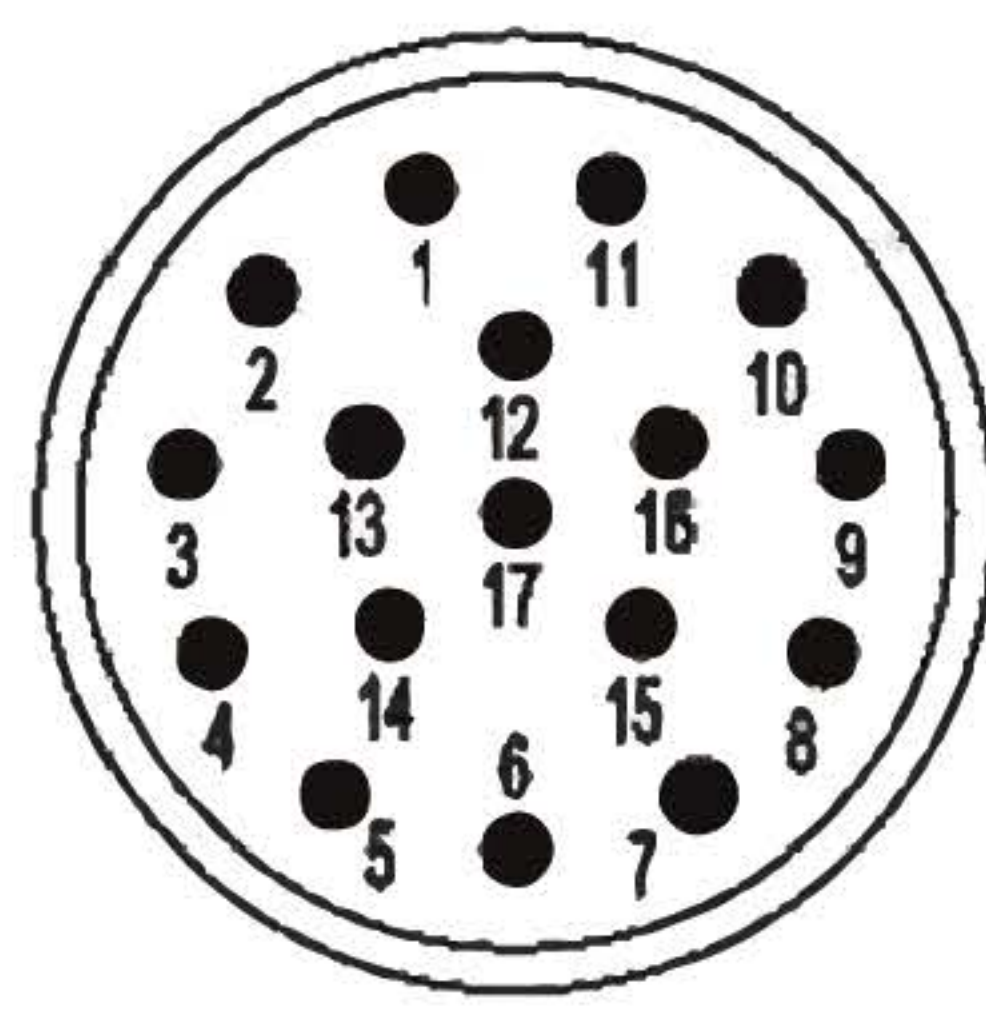
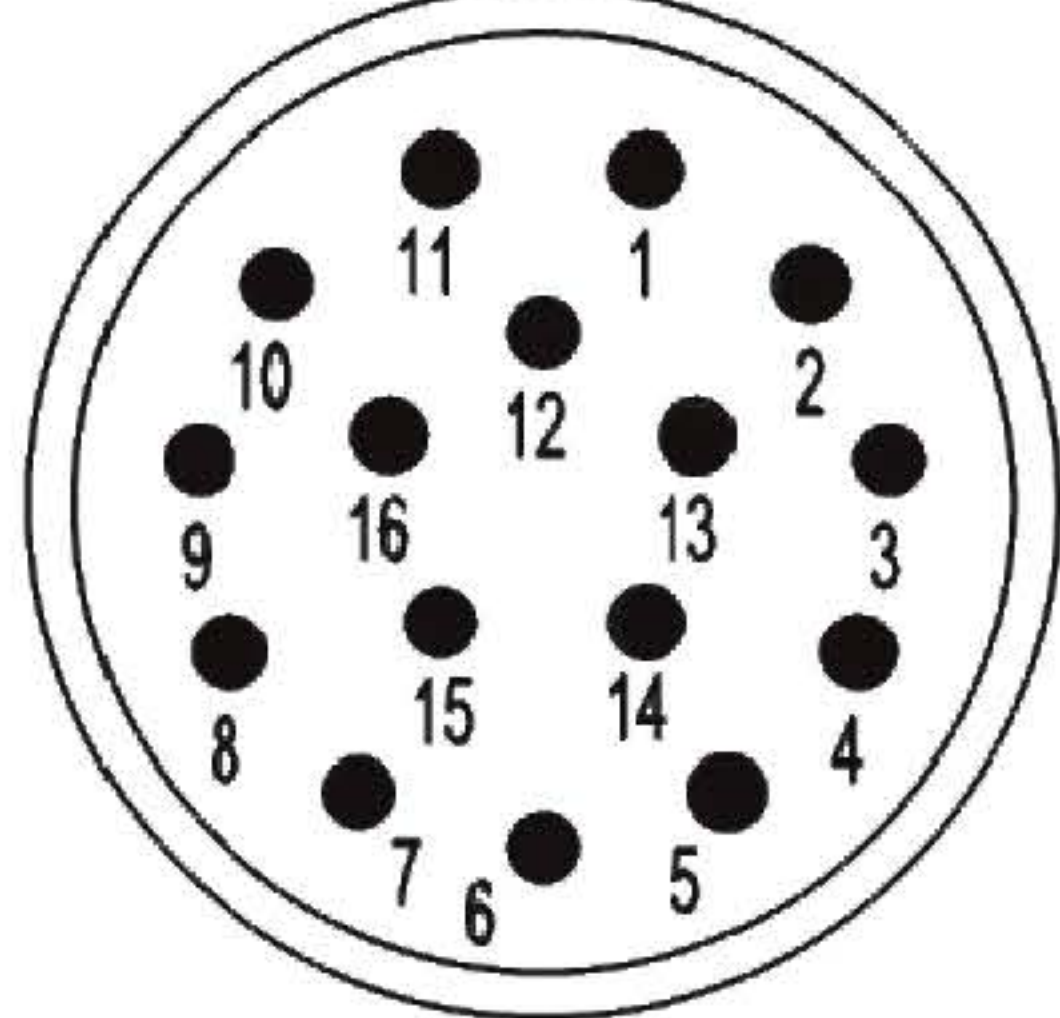
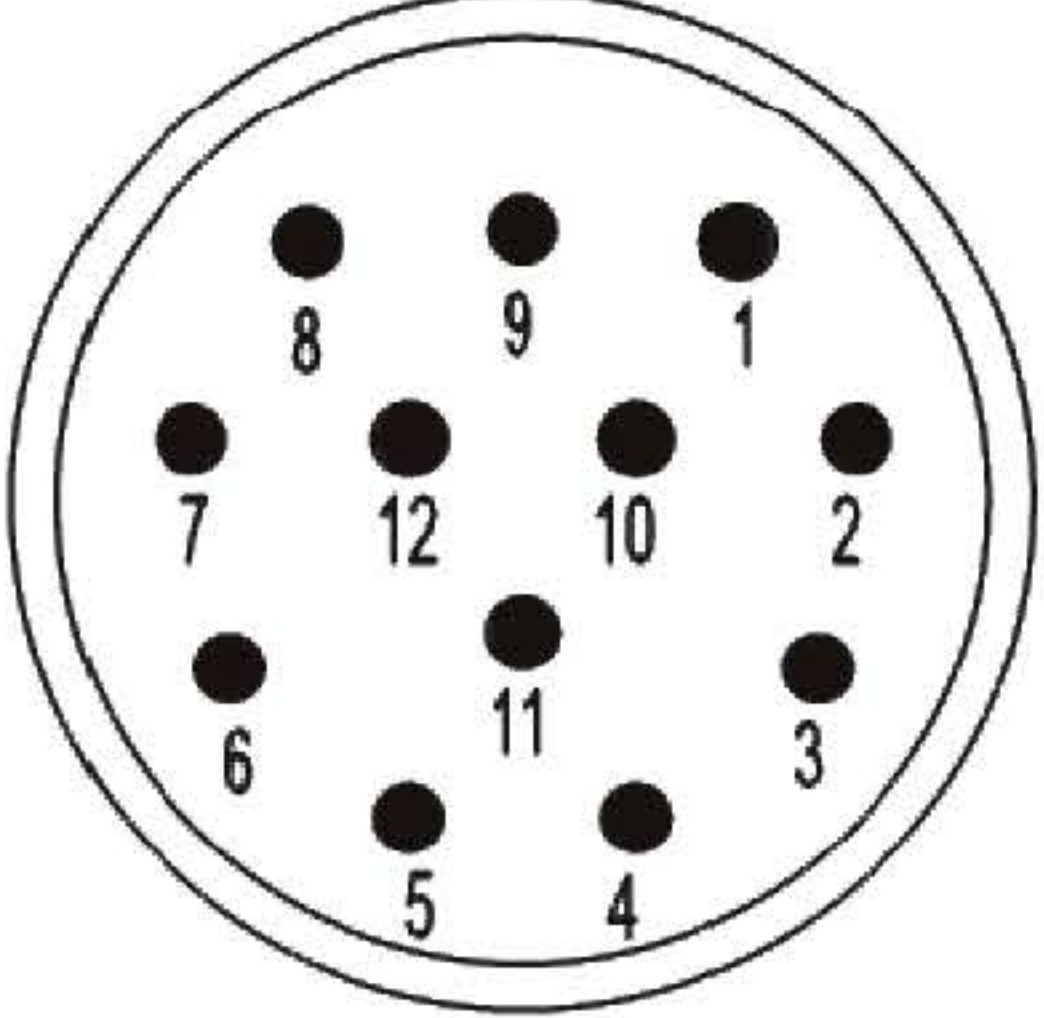
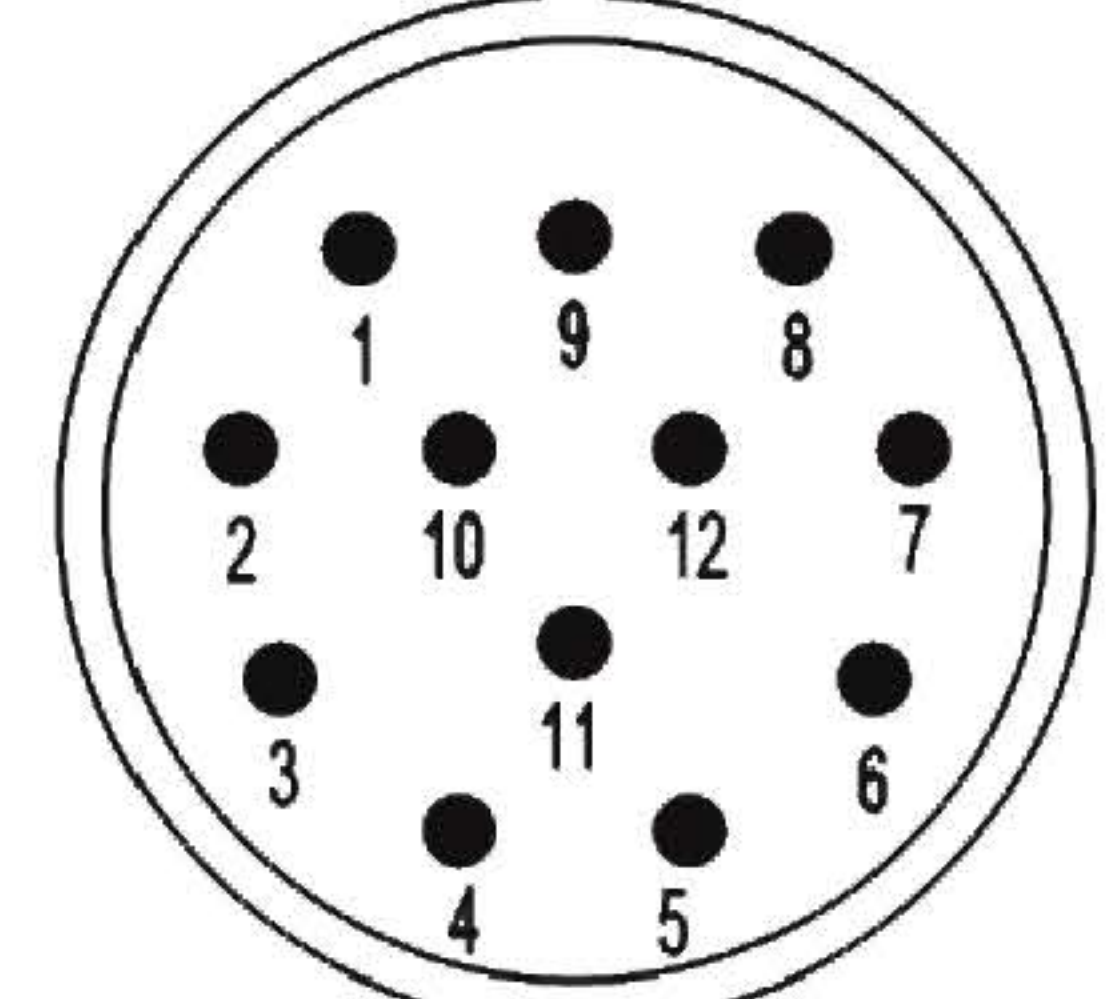
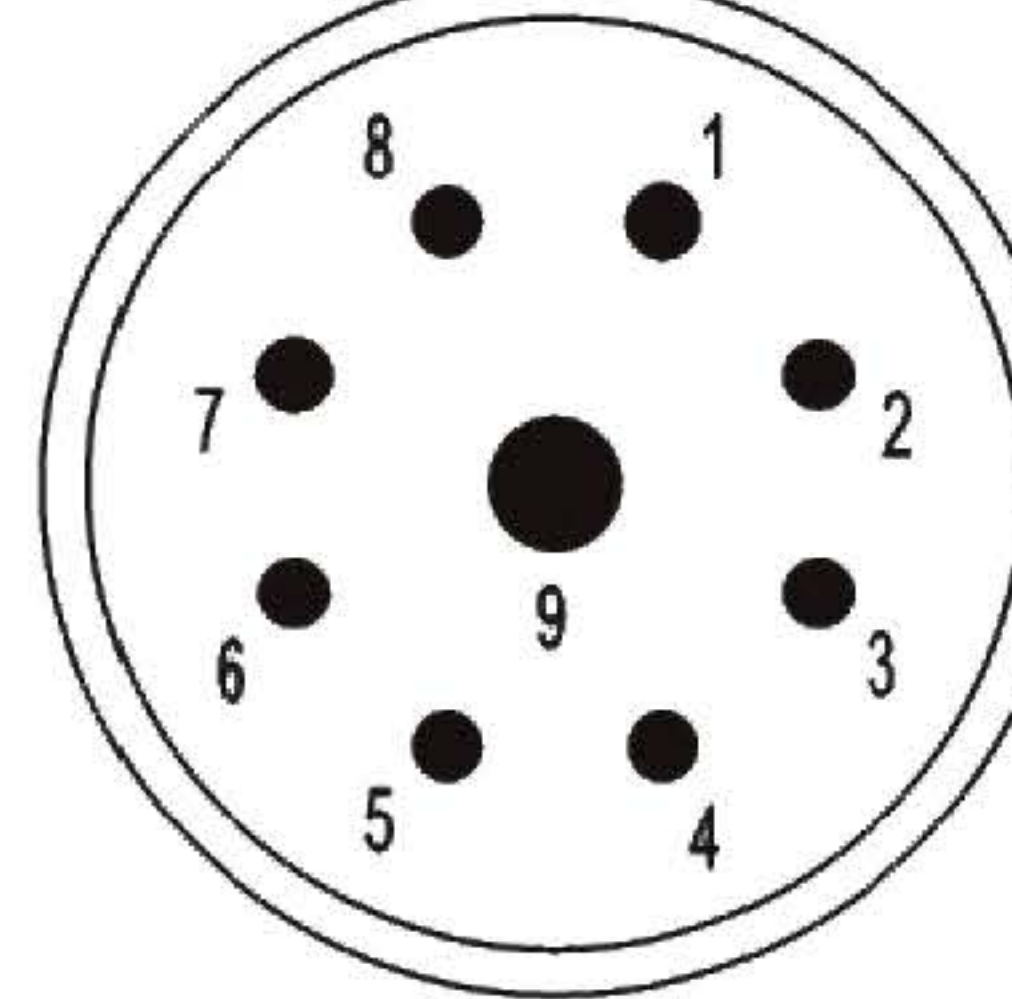
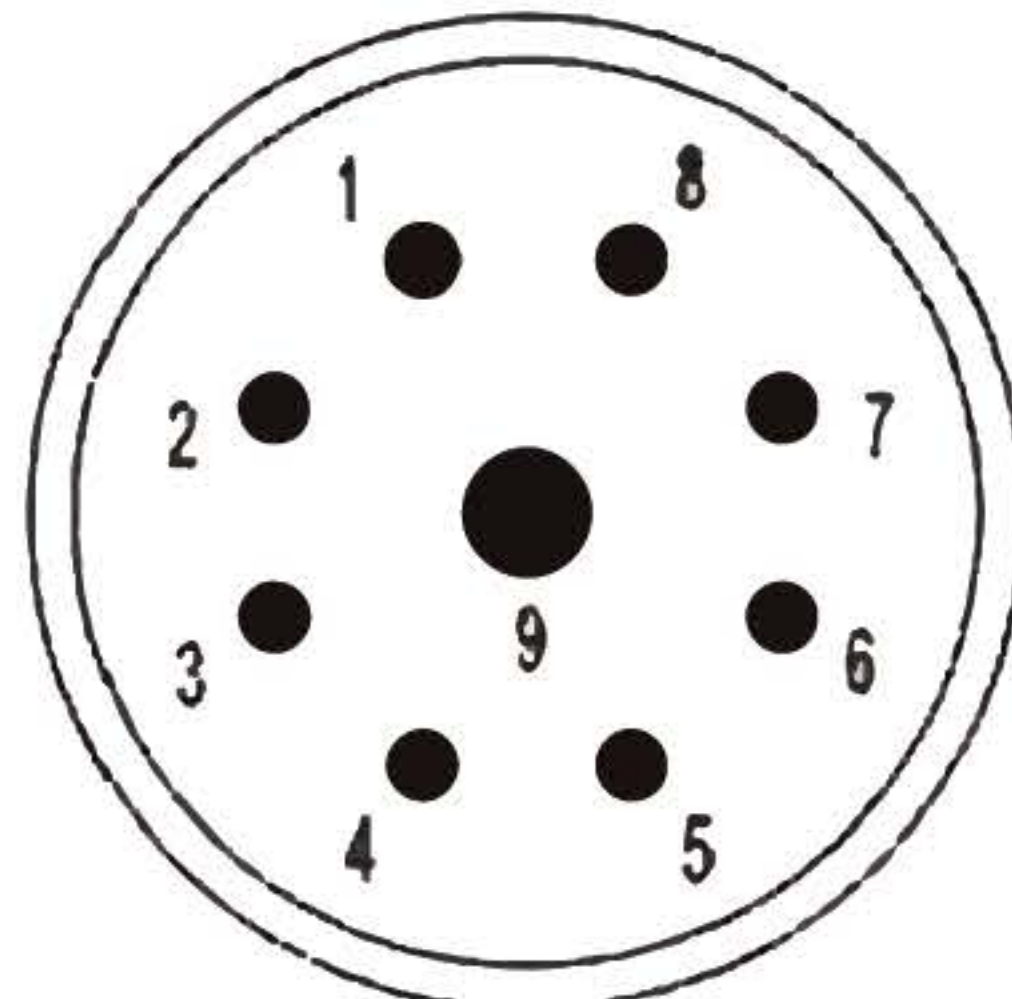
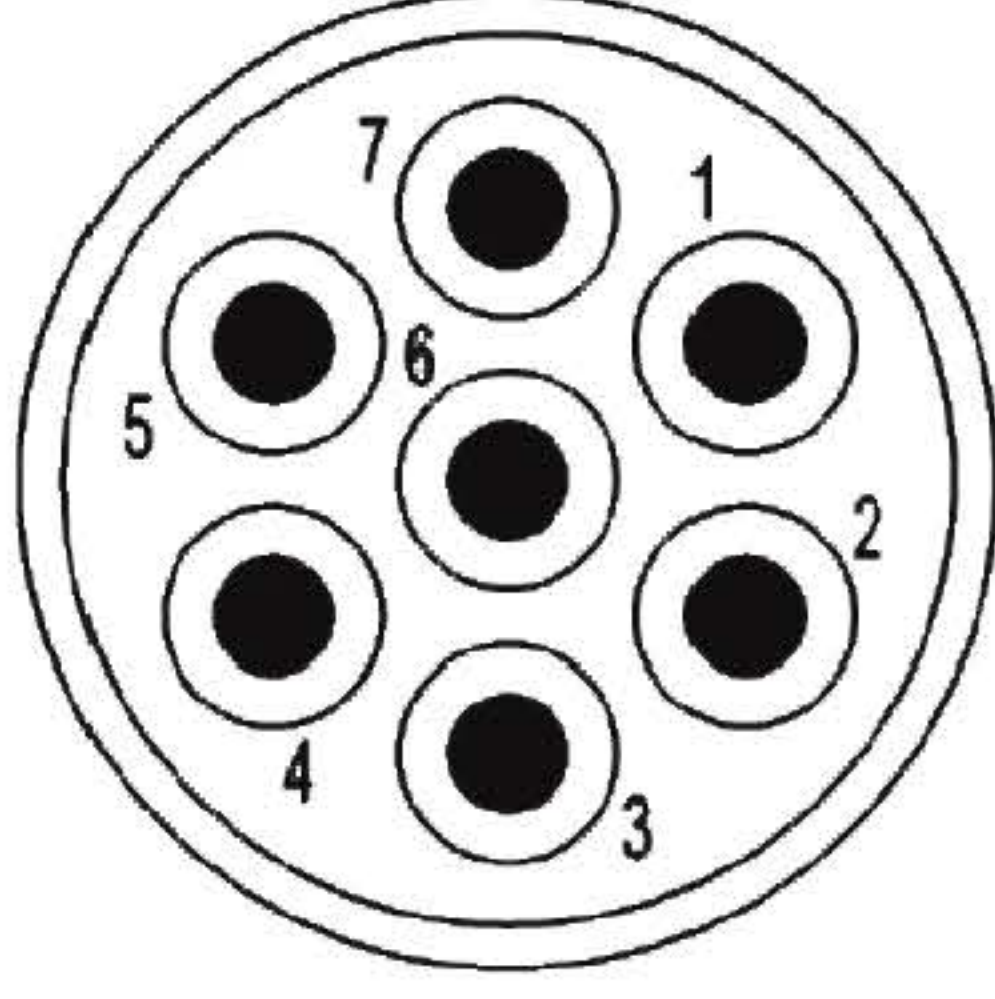
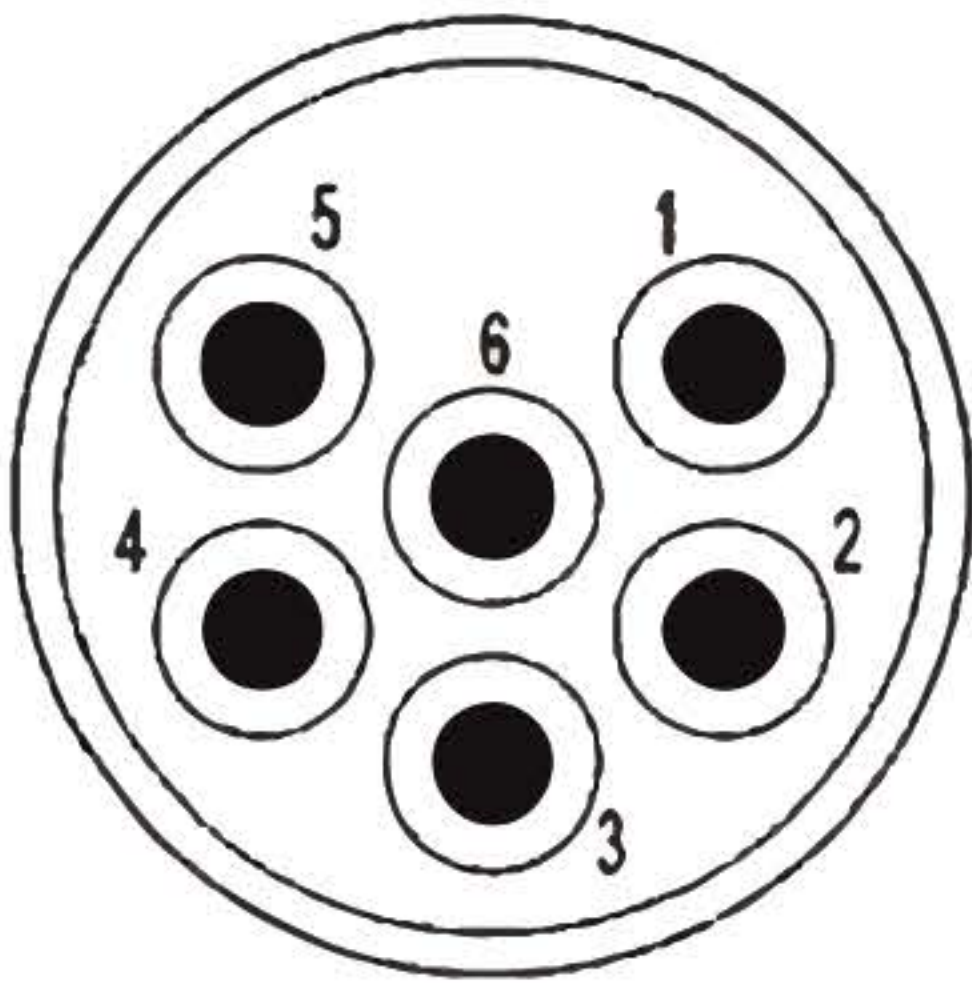

IO

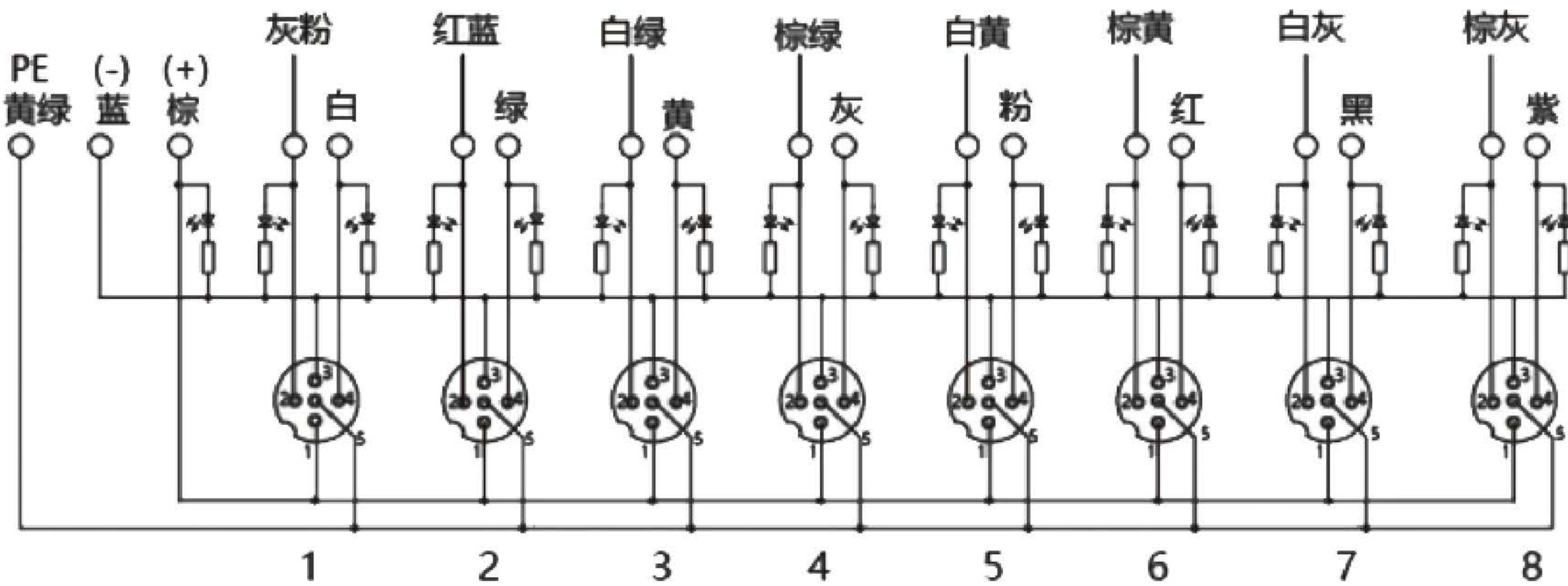

M8/ M12 Distribution Systems

PNP

针脚定义:

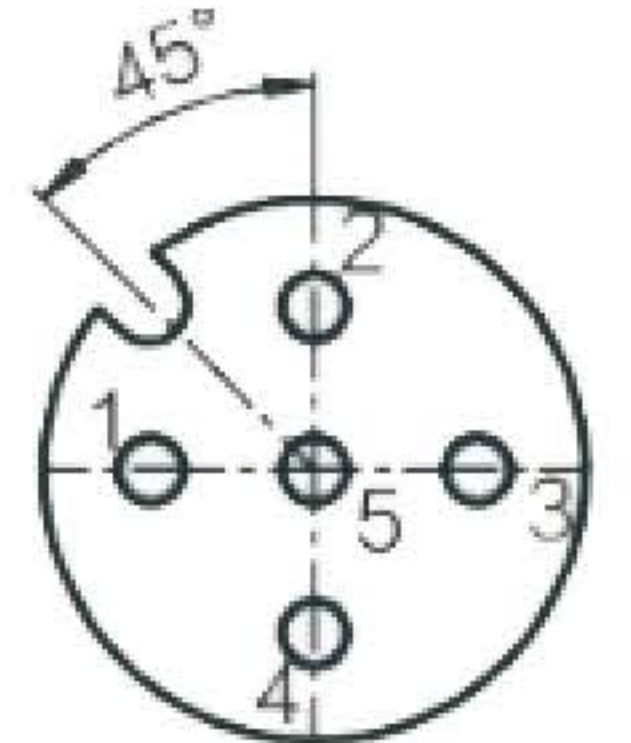

- Pin 1: (+)
- Pin 2: (N/C)/(S2)
- Pin 3: (-)
- Pin 4: (N/O)/(S1)
- Pin 5: (PE)

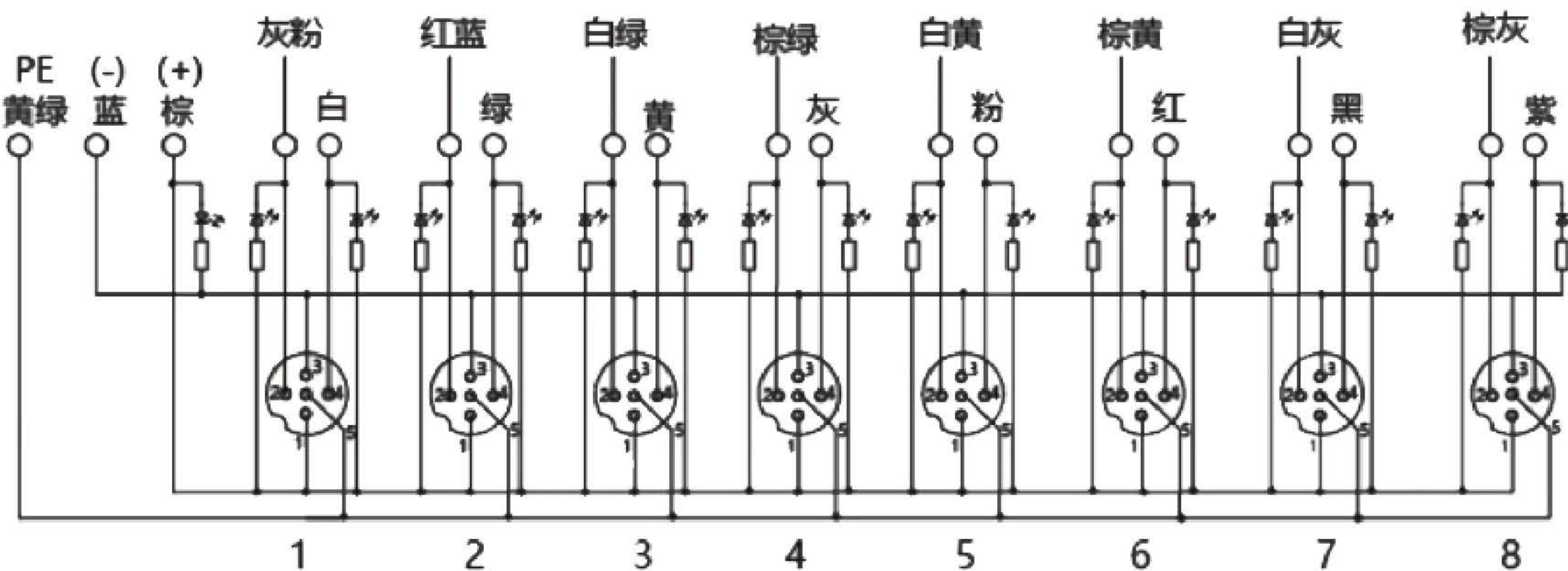

NPN

LED显示: 电源(绿)  
信号S1(黄)  
信号S2(黄)



A-code B-code  
C-code D-code  
X-code S-code  
L-code

## Flange Connectors



M12 X code

PCB-PIN



Customized Products for sensor



Flange connectors with multi-strand wire



7/8 Sensor Actuator Cables



Field-wireable connectors  
PG9 (OD 6~8mm)  
PG11(OD 8-10mm)

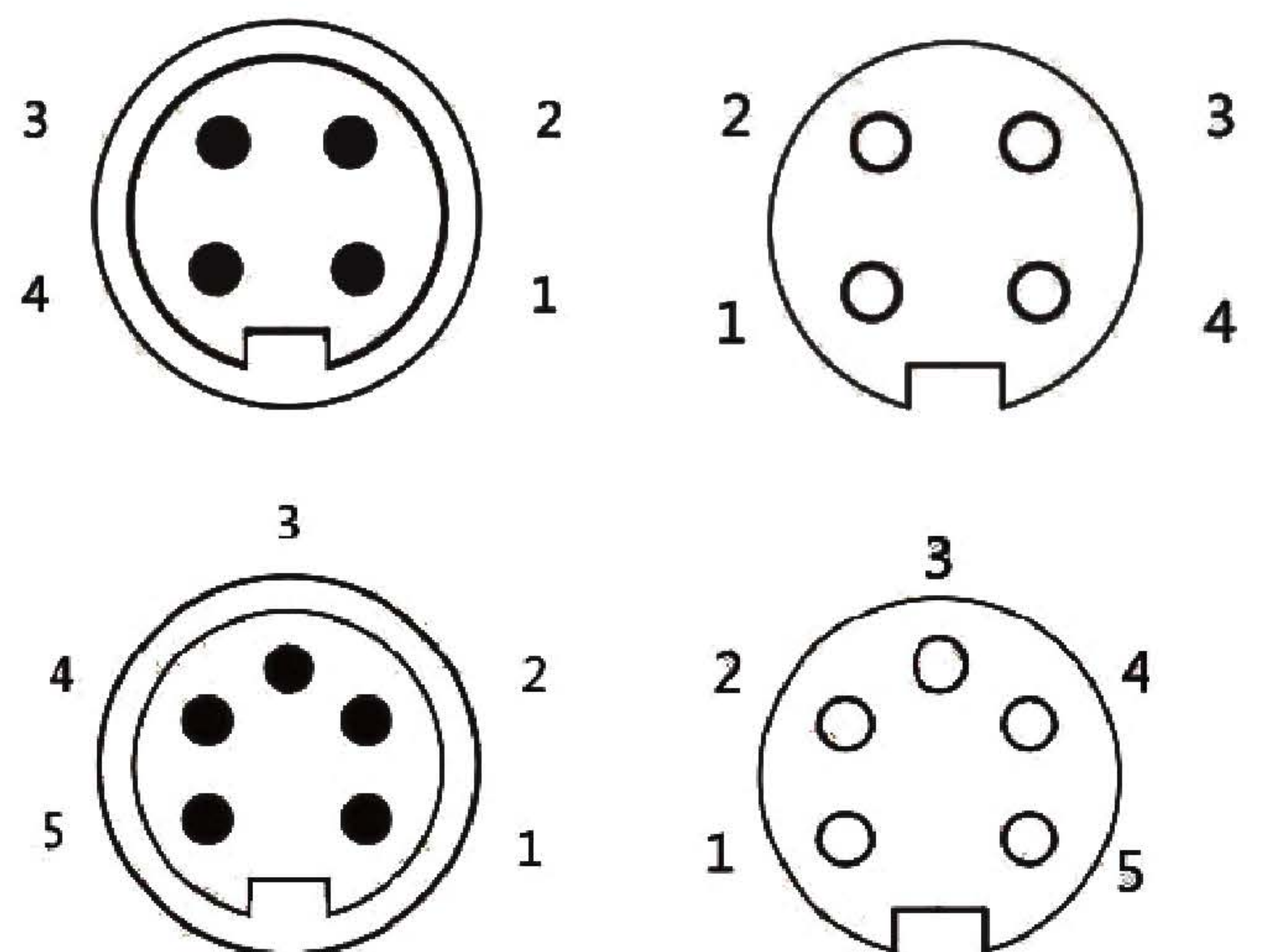

MALE

FEMALE



## 工业线束/工业连接器一站式选购

创新求发展，合作赢未来。

Innovation seeks development and cooperation wins the future.



### CONTACT US

TEL : 0086 021 67860082

Email : [eric@lzautomation.com](mailto:eric@lzautomation.com)

[jack@lzautomation.com](mailto:jack@lzautomation.com)

Website: <http://www.lzautomation.com>



访问我们，了解更多